

A N T H E M[®]

MRX SLM

A/V RECEIVER



OPERATING MANUAL



COMPATIBLE WITH

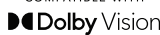

IMPORTANT SAFETY INSTRUCTIONS

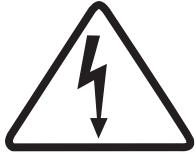

CAUTION

RISK OF ELECTRIC SHOCK DO NOT OPEN



CAUTION: TO REDUCE THE RISK OF ELECTRIC SHOCK, DO NOT REMOVE THE COVER. NO USER-SERVICEABLE PARTS INSIDE. REFER SERVICING TO QUALIFIED SERVICE PERSONNEL

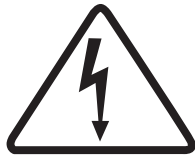

The lightning flash with arrowhead symbol within an equilateral triangle is intended to alert the user to the presence of uninsulated "dangerous voltage" within the product's enclosure that may be of sufficient magnitude to constitute a risk of electric shock to persons.



The exclamation point within an equilateral triangle is intended to alert the user to the presence of important operating and maintenance (servicing) instructions in the literature accompanying the appliance.

1. Read these instructions.
2. Keep these instructions.
3. Heed all warnings.
4. Follow all instructions.
5. Do not use this apparatus near water.
6. Clean only with a dry cloth.
7. Install in accordance with the manufacturer's instructions.
8. Do not install near any heat sources such as radiators, heat registers, stoves or other apparatus (including amplifiers) that produce heat.
9. Do not defeat the safety purpose of the polarized or grounding-type plug. A polarized plug has two blades with one wider than the other. A grounding-type plug has two blades and a third grounding prong. The wide blade or the third prong is provided for your safety. When the provided plug does not fit into your outlet, consult an electrician for replacement of the obsolete outlet.
10. Protect the power cord from being walked on or pinched, particularly at plugs, convenience receptacles and the point where they exit from the apparatus.
11. Only use the attachments/accessories specified by the manufacturer.
12. Use only with a cart, stand, tripod, bracket or table specified by the manufacturer, or sold with the apparatus.
13. Unplug this apparatus during lightning storms or when unused for long periods of time.
14. Refer all servicing to qualified service personnel. Servicing is required when the apparatus has been damaged in any way, such as power supply cord or plug is damaged, liquid has been spilled or objects have fallen into the apparatus, the apparatus has been exposed to rain or moisture, does not operate normally, or has been dropped.
15. Do not operate this apparatus at an altitude over 6561 ft / 2000 m.

WARNING: To reduce the risk of fire or electric shock, do not expose this apparatus to rain or moisture. Avoid installing this unit where foreign objects may fall onto this unit and/or this unit may be exposed to liquid dripping or splashing. On the top of this unit, do not place:

- Burning objects (i.e. candles), as they may cause fire, damage to this unit, and/or personal injury.
- Containers with liquid in them, as they may fall and liquid may cause electrical shock to the user and/or damage to this unit.

Apparatus shall not be exposed to dripping or splashing and no objects filled with liquids, such as vases, shall be placed on the apparatus.

Install it away from direct sunlight, heat sources, vibration, dust, moisture, and/or cold.

Do not cover this unit with a newspaper, tablecloth, curtain, etc. in order not to obstruct heat radiation. If the temperature inside this unit rises, it may cause fire, damage to this unit, and/or personal injury.

Install this unit near the AC outlet and where the AC power plug can be reached easily.

This unit is not disconnected from the AC power source when it is turned off. This state is called the standby mode. In this state, this unit is designed to consume a very small quantity of power. To completely disconnect this apparatus from the AC mains, disconnect the power supply cord plug from the AC receptacle.

NOTE: This product is not an auto voltage receiver. Connect only to the prescribed AC source as shown above the AC inlet of the receiver. i.e., 120VAC 60Hz (250W maximum) or 220-240VAC 50Hz, 1-phase (250W maximum).

CAUTION: These servicing instructions are for use by qualified service personnel only. To reduce the risk of electric shock, do not perform any servicing other than that contained in the operating instructions, unless you are qualified to do so.

CAUTION: Changes or modifications to this equipment not expressly approved by Paradigm Electronics for compliance could void the user's authority to operate this equipment.

FCC WARNING: Changes or modifications not expressly approved by the party responsible for compliance could void the user's authority to operate the equipment.

This equipment has been tested and found to comply with the limits for a class B digital device, pursuant to part 15 of the FCC Rules. These limits are designed to provide reasonable protection against harmful interference in a residential installation. This equipment generates, uses and can radiate radio frequency energy and, if not installed and used in accordance with the instructions, may cause harmful interference to radio communications. However, there is no guarantee that interference will not occur in a particular installation. If this equipment does cause harmful interference to radio or television reception, which can be determined by turning the equipment off and on, the user is encouraged to try to correct the interference by one or more of the following measures:

- Reorient or relocate the receiving antenna.
- Increase the separation between the equipment and the unit.
- Connect the equipment into an outlet on a circuit different from that to which the unit is connected.
- Consult the dealer or an experienced radio / TV technician for help.

DO NOT LOCATE IN THE FOLLOWING PLACES:

To ensure long-lasting use, do not locate the unit:

- Exposed to direct sunlight.
- Near sources of heat such as heaters.
- Highly humid or poorly ventilated.
- Dusty.
- Subjected to mechanical vibrations.
- On wobbly, inclined, or otherwise unstable surfaces.
- Near windows where there is a chance of exposure to rain, etc.
- On top of an amplifier or other component which dissipates a great deal of heat.

To ensure proper heat radiation, ensure clearance from walls and other equipment according to diagram.

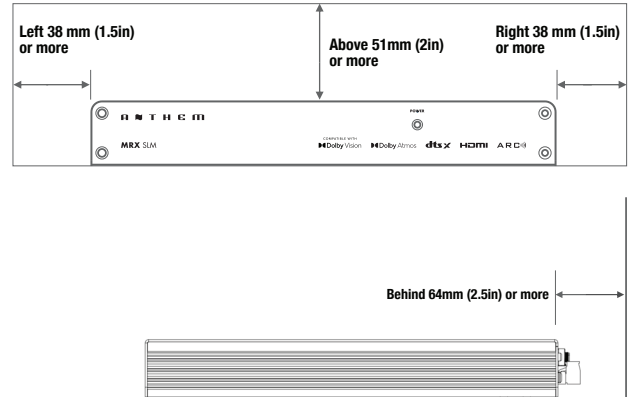

IMPORTANT INFORMATION FOR UK CUSTOMERS: DO NOT cut off the mains plug from this equipment. If the plug fitted is not suitable for the power points in your home or the cable is too short to reach a power point, then obtain an appropriate safety approved extension lead or consult your dealer. If, nonetheless, the mains plug is cut off, REMOVE THE FUSE and dispose of the PLUG immediately, to avoid possible shock hazard by inadvertent connection to the mains supply. If this product is not provided with a mains plug, or one has to be fitted, then follow the instructions given below:

IMPORTANT: DO NOT make any connection to the larger terminal which is marked with the letter "E" or by the safety earth symbol or colored GREEN or GREEN AND YELLOW.

The wires in the mains lead on this product are colored in accordance with the following code:

BLUE – NEUTRAL
BROWN – LIVE

As these colors may not correspond with the colored markings identifying the terminals in your plug, proceed as follows:

The BLUE wire must be connected to the terminal marked with the letter "N" or colored BLACK.

The BROWN wire must be connected to the terminal marked with the letter "L" or colored RED.

When replacing the fuse, only a correctly rated and approved type should be used, and be sure to re-fit the fuse cover. If in doubt consult a competent electrician.

NOTES ON ENVIRONMENTAL PROTECTION

At the end of its useful life, this product must not be disposed of with regular household waste but must be returned to a collection point for the recycling of electrical and electronic equipment. The symbol on the product, user's manual and packaging, point this out. The materials can be reused in accordance with their markings. Through re-use, recycling of raw materials or other forms of recycling of old products, you are making an important contribution to the protection of our environment. Your local administrative office can advise you of the responsible waste disposal point.

INFORMATION ABOUT COLLECTION AND DISPOSAL OF WASTE BATTERIES (DIRECTIVE 2006/66/EC OF THE EUROPEAN PARLIAMENT AND THE COUNCIL OF EUROPEAN UNION) (for European customers only)

Batteries bearing any of these symbols indicate that they should be treated as "separate collection" and not as municipal waste. It is encouraged that necessary measures are implemented to maximize the separate collection of waste batteries and to minimize the disposal of batteries as mixed municipal waste. End-users are exhorted not to dispose waste batteries as unsorted municipal waste. In order to achieve a high level of recycling waste batteries, discard waste batteries separately and properly through an accessible collection point in your vicinity. For more information about collection and recycling of waste batteries, please contact your local municipality, your waste disposal service or the point of sale where you purchased the items.

By ensuring compliance and conformance to proper disposal of waste batteries, potential hazardous effects on human health is prevented and the negative impact of batteries and waste batteries on the environment is minimized, thus contributing to the protection, preservation and quality improvement of the environment.

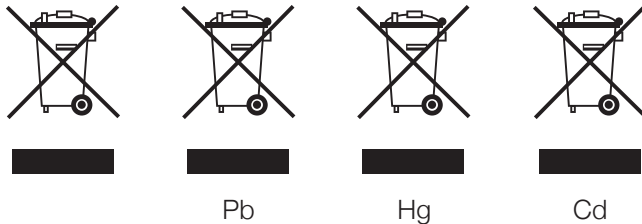

Paradigm Electronics Inc. and any related party assume no liability for the user's failure to comply with any requirements.

Anthem, AnthemLogic, ARC, Sonic Frontiers, and Paradigm are trademarks or registered trademarks of Paradigm Electronics Inc. © Paradigm Electronics Inc. All rights reserved. The information contained herein may not be reproduced in whole or in part without our express written permission. We reserve the right to change specifications or features without notice as design improvements are incorporated.

Apple, AirPlay and Mac are trademarks of Apple Inc., registered in the U.S. and other countries and regions.

Use of the Works with Apple AirPlay badge means that an accessory has been designed to work specifically with the technology identified in the badge and has been certified by the developer to meet Apple performance standards.

To use AirPlay with Anthem MRX SLM, the latest version of iOS, iPadOS, or macOS is recommended.

Google, Google Play, Google Home, and Google Cast are trademarks of Google LLC.

Wi-Fi® is a registered trademark of the Wi-Fi Alliance. The Wi-Fi CERTIFIED Logo is a certification mark of the Wi-Fi Alliance.

The Bluetooth® word mark and logos are registered trademarks owned by Bluetooth SIG, Inc. and any use of such marks by Anthem is under license. Other trademarks and trade names are those of their respective owners.

Dolby, Dolby Atmos, Dolby Vision and the double-D symbol are registered trademarks of Dolby Laboratories Licensing Corporation. Manufactured under license from Dolby Laboratories. Confidential unpublished works. Copyright © 2012-2021 Dolby Laboratories. All rights reserved.

For DTS patents, see <http://patents.dts.com>. Manufactured under license from DTS, Inc. or DTS Licensing Limited. DTS, DTS:X, and the DTS and DTS:X logos are registered trademarks or trademarks of DTS, Inc. in the United States and other countries. © 2021 DTS, Inc. ALL RIGHTS RESERVED.

The terms HDMI, HDMI High-Definition Multimedia Interface, HDMI trade dress and the HDMI Logos are trademarks or registered trademarks of HDMI Licensing Administrator, Inc.

All other trademarks are the property of their respective owners.

LICENSE INFORMATION FOR THE SOFTWARE USED IN THE UNIT

This product contains one or more free or open-source software programs originating from third parties. This free and open-source software is subject to the terms of the GNU General Public License, GNU Library/Lesser General Public License, or other different and/ or additional copyright licenses, notices, and disclaimers. To understand your rights under these licenses, please refer to the specific terms of the licenses, notices, and disclaimers provided in the device's Web UI under the ⓘ (Information) page.

To receive a copy of the source code for the open-source software programs included in this product, please make your request to our customer service center.

Paradigm Electronics will distribute such source code to you on a disc for a charge covering the cost of performing such distribution, such as the cost of media, shipping and handling.

All of the above-referenced licenses, notices, and disclaimers are reproduced and available with such source code. However, note that we make no guarantees concerning the source code. Please also understand that we do not offer support for the contents of the source code. This offer is valid for a period of three (3) years following the date of distribution of this product by Paradigm Electronics.

The ⓘ (Information) page on the Web UI contains the latest software licenses used for this unit. To maintain the correct content, the original (English) is used.

The Spotify software is subject to third-party licenses found here:
www.spotify.com/connect/third-party-licenses

TABLE OF CONTENTS

INTRODUCTION

- 1** **1.1** Before Making Connections
- 1** **1.2** In-Use Notices
- 2** **1.3** Front Panel
- 3** **1.4** Rear Panel
- 6** **1.5** Speaker Positioning
- 7** **1.6** 5.1-Channel Speaker Positioning
- 8** **1.7** 2.1.2 and 3.1.2-Channel Speaker Positioning
- 9** **1.8** Height Effects Speaker Positioning

CONNECTIONS

- 10** **2.1** HDMI Video Input and Output
- 11** **2.2** Audio Connections
- 12** **2.3** Local Area Network
- 12** **2.4** Infra Red
- 12** **2.5** Power
- 12** **2.6** Chassis Ground

OPERATION

- 14** **3.1** Network Setup
- 15** **3.2** Anthem Remote App Operation
- 15** **3.3** Web User Interface Operation
- 16** **3.4** Traditional Remote Control Operation
- 17** **3.4.1** Power ON / OFF and Volume
- 17** **3.4.2** Listening Modes (Mode Button On Remote Control)
- 18** **3.4.3** Input Selection
- 20** **3.5** Streaming Via AirPlay®
- 20** **3.6** Streaming Via Google Cast
- 21** **3.7** Streaming Via Bluetooth

SETUP

- 22** **4.1** Information Page
- 22** **4.2** Quick Access
- 23** **4.3** System Setup – General Setup
- 25** **4.4** System Setup – Speakers Setup
- 28** **4.5** System Setup – Inputs Setup
- 32** **4.6** System Setup – Network Setup
- 33** **4.7** System Setup – Store / Load / Update

ANTHEM ROOM CORRECTION

- 36** **5.1** Anthem Room Correction (ARC®)
- 37** **5.2** Using ARC with the MRX SLM

- 38** FAQ
- 40** Specifications
- 42** Limited Warranty

INTRODUCTION

The MRX SLM is a small form-factor 5.1 A/V receiver capable of delivering 50W per channel. It includes the essential inputs (3.5 mm jack for analog audio, digital TOS input and HDMI®) and has a HDMI output supporting ARC and eARC. Audio streaming from various sources (Google Cast, Bluetooth, AirPlay® and various cloud services such as Spotify) are also accessible. Dolby Atmos® and DTS:X decoding as well as legacy Dolby®/DTS are supported. Room EQ is handled by award-winning Anthem Room Correction technology.

There is no display or volume control: all control and settings are available using a smartphone app, web browser or home automation system and basic operation can be achieved using the included remote. An external IR input can be optionally used when the unit is mounted behind the TV or away from the line of sight.

The unit has a variety of mounting options: rubber feet, snapping in a mounting bracket when locating behind a TV or on/in a wall (included in the accessory package) or in a standard 19" rack using a rack mount bracket.

1.1 BEFORE MAKING CONNECTIONS

Check that you have received all items listed below and report discrepancies to your dealer as soon as possible. In case the unit needs to be transported in the future, keep the packing materials. Retain the invoice that you received from your authorized Anthem dealer at time of purchase – without it, service will not be provided under warranty.

- MRX SLM
- Wall mount bracket
- Remote Control
- 2x Wireless Network Antennas
- 2x AAA Batteries (included with 120V Models ONLY)
- IEC Power Cord (US / UK / EU / AU types are supplied by factory, other types are normally provided by the local distributor)
- US power cord is supplied with the 120V model
- UK/EU/AU power cords are supplied with the 240V model
- External IR Receiver
- USB Microphone and mini USB to USB Type A cable
- Quick start guide
- 10-pin speaker terminal (attached to the unit)
- Stick-on rubber feet
- Warranty card

1.2 IN-USE NOTICES

- Disconnect the power cord before connecting or disconnecting any components.
- If the MRX SLM was transported or stored in the cold, let it reach room temperature before use.
- Due to continuing advances, operational characteristics may change. If this manual contains discrepancies please check www.anthemAV.com for the latest manual or software.

1.3 FRONT PANEL

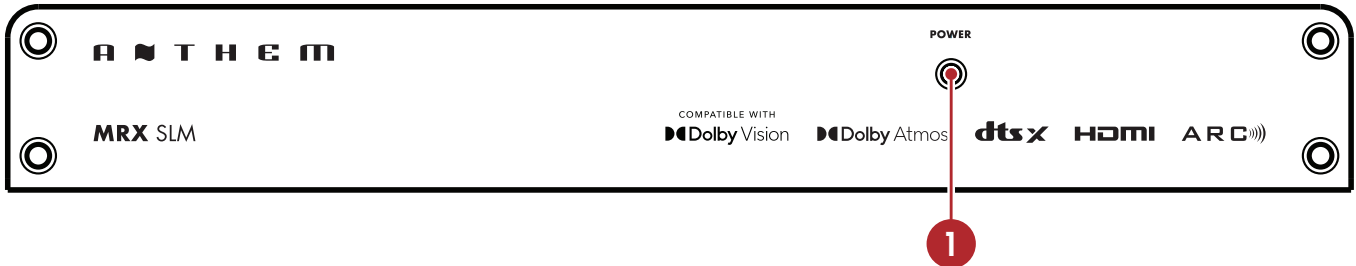

1 – Power / Status LED and Front IR receiver

When the LED is solid Blue, this indicates the unit is powered on.

When flashing twice per second, this indicates the unit is in Bluetooth pairing mode.

When flashing once per second, this indicates the unit is in WAC (Wireless Accessory Configuration) mode.

1.4 REAR PANEL

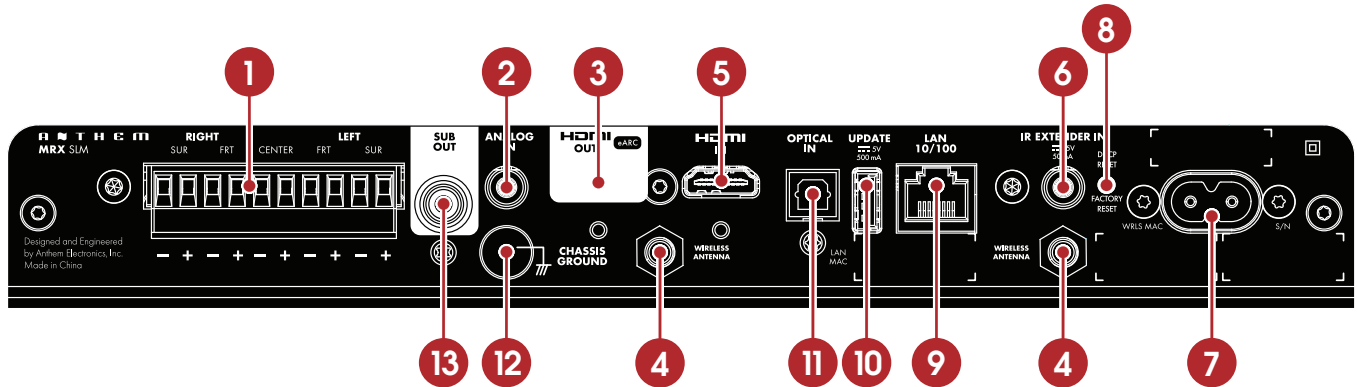

- 1 – Euroblock speaker connection
- 2 – 3.5 mm (1/8") analog audio input jack
- 3 – HDMI output - Supports Audio Return Channel (ARC) and enhanced Audio Return Channel (eARC)
- 4 – Dual-band wireless antenna connectors
- 5 – HDMI input
- 6 – External IR input
- 7 – AC input. The label above shows the operating voltage for which the unit has been configured (120VAC or 240VAC)
- 8 – DHCP reset / Factory Reset button
- 9 – 10/100 local area network connection for IP control and Anthem Room Correction
- 10 – USB jack for factory service
- 11 – Optical digital audio input
- 12 – Chassis ground screw
- 13 – Subwoofer output

REMOTE CONTROL BATTERY INSTALLATION

Install two AAA alkaline batteries in the MRX SLM remote control in the directions shown in the illustration below. When replacing batteries, always replace both of them with fresh batteries and use high quality AAA alkaline type. If not using the remote for an extended length of time, remove the batteries from the remote to avoid acid leakage that may damage the remote.

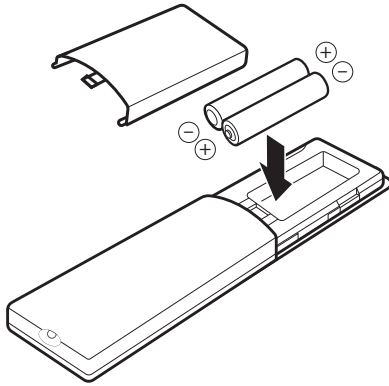

REMOTE CONTROL RANGE OF OPERATION

The MRX SLM remote control operates best when used within the range and distance shown in the illustration below. The IR receiver is located below the Power label on the front panel.

If the unit is not facing the listening position (for example, if the unit is mounted behind a TV or in wall), the external IR receiver (included with the accessories) can be used and mounted to face the listening position. Peel off the double-sided tape to affix the external IR receiver in place.

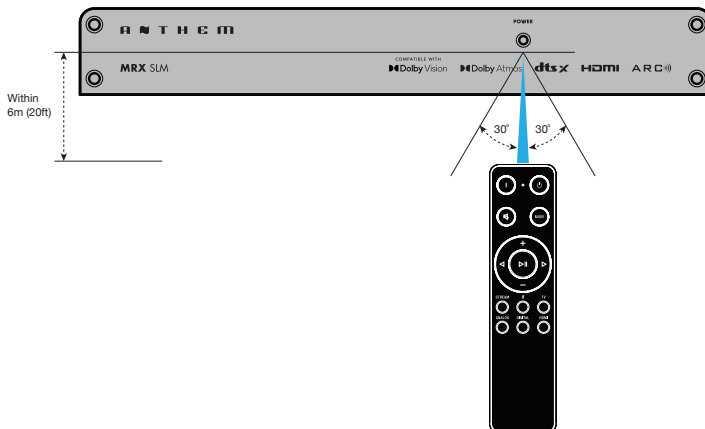

REAR AND FRONT IR INPUTS

If your remote control is not working and you have already checked the batteries, before contacting technical support, check that IR is set to “Front IR” if using the front panel IR or set to “Rear IR” if using the external IR extender in the Network / Control menu.

ANTHEM REMOTE CONTROL APP

A remote control app is available for free to iOS and Android users. To use this app, download it from the Google Play or Apple App Store, connect your MRX SLM to the same network as your iOS/Android device, and launch the app.

MOUNTING

Before connecting cables to the MRX SLM, you should find a good spot for it in your entertainment system. Thanks to its small foot print and versatility, the unit can be mounted several ways:

1. In a cabinet by adding stick-on rubber feet under the MRX SLM (included in the accessories package).
2. Attached to the back of your TV, on the wall or inside a wall cabinet located between 2 studs, by making use of the universal mounting bracket (included in the accessories package). Install the mounting bracket first and then simply snap-in the MRX SLM in place.
3. In a 19-inch rack using the rackmount kit (available as an option). Remove the 4 screws at the front using a Torx T10 screwdriver and attach the rack mount plate by re-using the same screws.

1.5 SPEAKER POSITIONING

Your MRX SLM allows connection of up to six channels (5 speakers, 1 subwoofer). When setting up your speakers, care should be taken to achieve the best possible immersive audio experience. The factory defaults to a 5.1 speaker configuration: fronts/center/surrounds and subwoofer. The surround channels can be configured in the setup menu for a number of other configurations. Please read the setup section to take full advantage of all the features.

FRONT LEFT & RIGHT

The front speakers are what you hear when listening to 2 channel recordings but also play a large part in your home theater setup along with the centre channel playing the majority of content.

CENTER

The center channel is the most important speaker in a home theater system, as it reproduces almost all of the dialogue, and a large portion of the front speaker information.

SURROUND LEFT & RIGHT

Surround speakers reproduce the information that makes sounds wrap around your home theater space.

SUBWOOFER

With any surround sound system, you will need one or more high-quality subwoofers (the .1 in 5.1- or 3.1.2-channel surround systems). Most movie soundtracks contain large amounts of bass information as part of the LFE (Low Frequency Effect) track that sends information directly to your subwoofer. Good subwoofers will provide a foundation for the rest of the system, and add “weight” to movies and music.

HEIGHTS

Up to two height speakers (the .2 and in 3.1.2-channel surround systems) can be connected to allow 3-dimensional Dolby Atmos and DTS:X surround sound. Height speakers reproduce the information that makes it sound as if planes are flying over your head and other similar effects.

Note that as the MRX SLM has only 5 speaker outputs, you need to select to either have surrounds or heights speakers.

1.6 5.1-CHANNEL SPEAKER POSITIONING

This illustration shows the recommended speaker placement for a 5.1 setup.

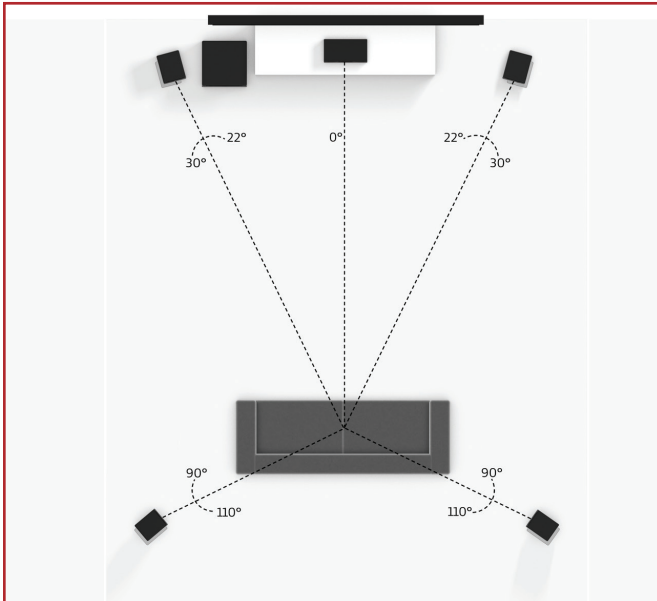

5.1 Configuration

1.7 2.1.2 and 3.1.2-CHANNEL SPEAKER POSITIONING

These illustrations show some possible speaker placements when using the surround channels as heights.

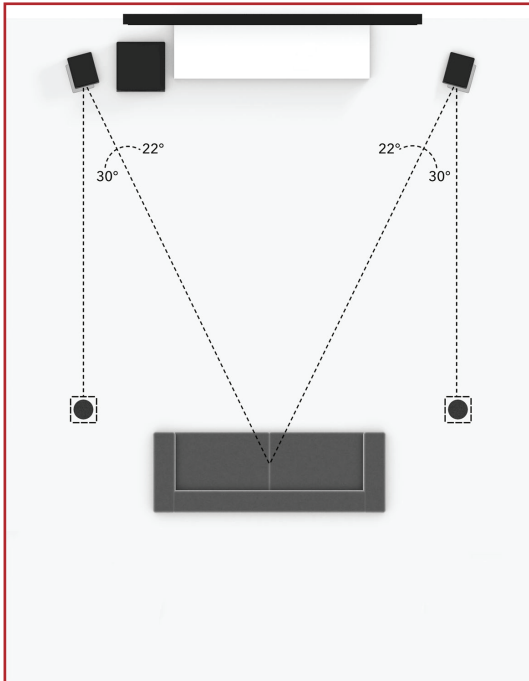

2.1.2 Configuration
with one pair in-ceiling height speakers

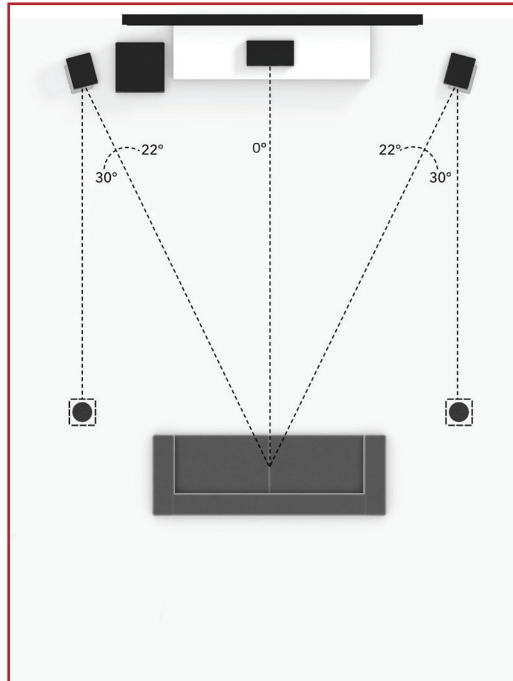

3.1.2 Configuration
with one pair in-ceiling height speakers

1.8 HEIGHT EFFECTS SPEAKER POSITIONING

This illustration shows recommended speaker placement when using middle channel height effects.

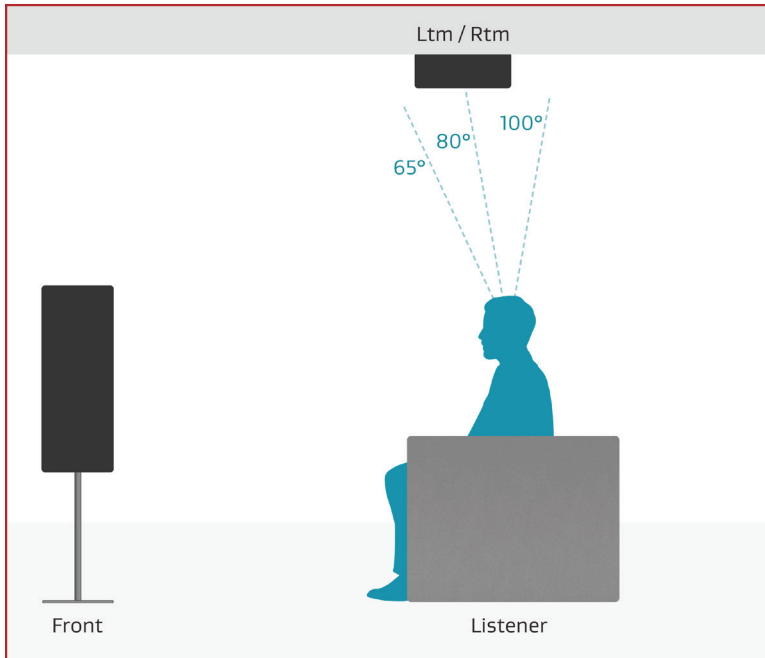

One pair in-ceiling height speakers (*side view*)

This section describes connections between system components. Configuration of input and output will be discussed later, in section 3.

2.1 HDMI VIDEO INPUT AND OUTPUT

An HDMI connection carries video and audio signals together. Connect the HDMI output from the MRX to a display with a HDMI input – one with the appropriate version of High-bandwidth Digital Content Protection (HDCP) is required to display copy-protected material.



Insert HDMI cables gently, as the connector is more delicate than traditional ones. Damaged cables can damage jacks, and the warranty does not cover jack replacement. Therefore, replacing HDMI cables is recommended if there is any chance of damage with the existing cable.

Use only certified High-Speed cables and connecting devices. Cables and connecting devices that worked in an older setup may not necessarily be compatible with newer video formats such as Deep Color, UHD, or high frame rates. If you are using adapters or port savers, start troubleshooting by eliminating them since they can affect bandwidth.

2.2 AUDIO CONNECTIONS

HDMI AND OPTICAL DIGITAL AUDIO

Digital audio sources can be connected using an HDMI or optical cable. These connections can carry either linear PCM or bitstream (Dolby Digital, and DTS audio formats). An HDMI connection is generally preferred to ensure the use of lossless audio when sources provide it, although you can also use an optical connection for sources outputting 2-channel PCM, Dolby Digital 5.1, and DTS 5.1 without affecting audio quality.

HDMI ARC AND eARC AUDIO RETURN CHANNEL

If your television provides audio through HDMI ARC (Audio Return Channel) or eARC (Enhanced Audio Return Channel), for example, when it accesses streaming media sources, it can send the audio to the MRX SLM, eliminating the need for a separate audio connection from the television.

If using ARC or eARC, ensure that CEC is turned ON on both the TV and MRX SLM. If using eARC, ensure that the HDMI cable connecting the TV to the MRX SLM supports eARC. In both cases, make sure to use the dedicated HDMI connector on your TV that supports ARC or eARC. Beware that the MRX SLM CEC control is turned OFF by default. You may also need to change the settings on your TV to select HDMI eARC or HDMI ARC for the audio output and set the digital output format to bitstream audio or pass through.

ANALOG AUDIO

If a digital output is not available from your source or if an additional source is desirable, the 3.5 mm (1/8") analog audio jack can be used as another source.

If HDMI audio from a Dolby Digital, DTS, or 2-channel PCM source is problematic, or takes too long to switch, we recommend the use of an optical or analog audio connection (you can still use HDMI for video). Older cable and satellite devices often benefit from this.

CONNECTING SUBWOOFERS

Although subwoofers are considered to be a speaker channel, they are generally self-amplified, and thus, connect in the same way you'd connect an external amplifier. Your MRX SLM features one subwoofer output.

SPEAKER CONNECTIONS

Remove the Euroblock connector by gently pulling away until it releases. Use a small slotted screwdriver to loosen and tighten each contact on the Euroblock when inserting the speaker wire (up to 12 AWG / 4mm²).

Identify which speaker wires connect to Front left/right, Surround left/right and Center speakers.

Connect the red (+) connection of the speaker to the positive (+) contact on the Euroblock connector, as indicated by the printing located on the SLM (above the connector) and on the connector itself. Connect the black (-) connection of the speaker to the negative (-) contact on the Euroblock connector as indicated by the printing located on the MRX SLM (above the connector) and on the connector itself.

Do not connect more than one speaker to each speaker output on the Euroblock connector. Be sure to turn off the power when connecting or disconnecting anything. Only use speakers rated for use with the MRX SLM.

2.3 LOCAL AREA NETWORK

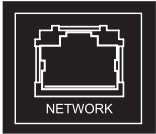

Configuring Anthem Room Correction, streaming or using IP control requires a network connection. To use a wired network connection, connect your SLM to a router using a 10/100 Ethernet cable.



If using a wireless connection, connect the two included network antennas to the rear panel of the SLM. The setup section of this manual explains how to set up a wireless connection. Please note, if mounting the MRX SLM in a metal rack, we recommend a wired network connection, especially if the wireless router is in a different room or if anything else can impact the signal strength.

Wireless antennas are also required for a Bluetooth connection.

If using a firewall for security, ensure that the MRX SLM is permitted to join the network.

2.4 INFRA RED



An external IR receiver allows the use of the remote control from another location in your home or if the unit is located behind a TV or in a wall. Turn OFF AC power from the unit and connect supplied IR receiver to the IR IN jack and affix in place by using the double-sided tape.

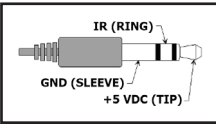

The external IR receiver is a powered style which is also commonly used with set top boxes. The pin-out is as follow:

SLEEVE: GND

RING: IR Signal

TIP: +5 VDC (supplied by MRX SLM)

2.5 POWER

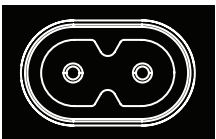

Insert the power cord into the MRX SLM AC input, and plug the cord into a wall outlet. Ensure that the AC supply matches the voltage rating shown above the AC inlet of the MRX SLM. The 240V models support voltages from 220V to 240V. Route audio and video cables away from the power cord to reduce potential sources of hum and other interference.

2.6 CHASSIS GROUND



The MRX SLM is powered using a double-insulated power cord and therefore does not have an earth-ground connection to avoid hum. If an earth-ground connection is required, or if connecting to another chassis ground, you can connect a wire using the thumbscrew.

TYPICAL CONNECTION

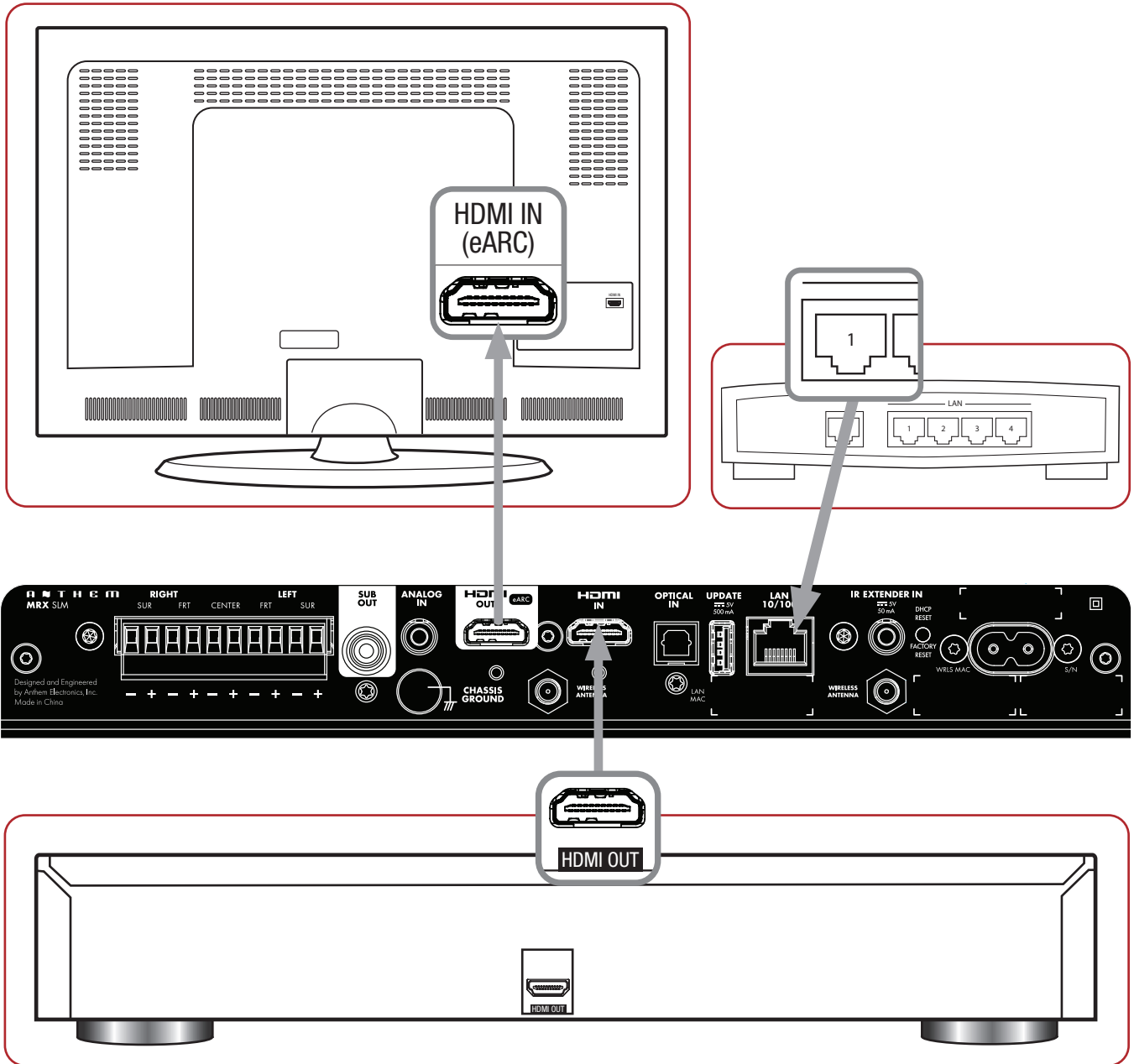

The MRX SLM does not have a traditional front panel with volume knob and display but can be controlled using a traditional IR remote control, Anthem Remote App (iOS and Android available), web interface, via some custom home automation equipment (such as Crestron or Control4) and even other applications such as Spotify or Google Home. The unit can be controlled by all these control devices at the same time. For example, you can use the Spotify app to select your favorite play list and adjust the volume, but you can then use the MRX SLM remote to skip a track or the Anthem Remote App to change the listening mode.

3.1 NETWORK SETUP

If you intend to only use the IR remote and streaming only via Bluetooth, no network connection is required. BUT you will need one to run the Anthem Remote App, access the setup parameters, do an Anthem Room Correction, install software updates or stream audio from the internet.

You can connect to your network several ways:

- 1. Ethernet/LAN Connection:** The simplest way to connect your MRX SLM to your network is by connecting it via an Ethernet cable to the LAN 10/100 port at the back of the MRX SLM. This will provide the quickest setup, most secure and most reliable network connection.
- 2. Wi-Fi Configuration via Apple® iOS:**
 - a. Enter your iOS device Wi-Fi Settings Menu.
 - b. During the first 15 minutes after applying AC power, the unit will enter WAC mode and will allow you to configure the wireless network using your iOS device. You can then locate your MRX SLM under “Set up new AirPlay speaker.” The MRX SLM will be shown as “MRX SLM-xxxxxx” in the list of available devices (where xxxxxx represents the last few characters of the LAN MAC ID, as shown at the back of the unit)
 - c. Select your MRX SLM unit and follow the instructions to connect it to your network.
- 3. Wi-Fi Configuration via Android:**
 - a. Download the Google Home application from the Play Store and launch it.
 - b. You should be prompted that there is a device available for setup. Follow the instructions to add it to the network. If not, tap “+ Add” followed by “Google Nest or partner” device and follow the instructions on screen. The MRX SLM will be shown as “MRX SLM-xxxxxx” in the list of available devices (where xxxxxx represents the last few characters of the LAN MAC ID, as shown at the back of the unit).

NOTE: *If you connect to your network before connecting speakers, you will obviously not hear the connection chime.*

- 4. Wi-Fi Configuration via setup menu:**
 - a. Connect the MRX SLM to your network using a wired Ethernet/LAN cable.
 - b. Setup a wireless connection by following the instructions shown in the SYSTEM SETUP – Wi-Fi CONFIGURATION.
 - c. Disconnect the Ethernet/LAN cable. The unit will then connect to the wireless network automatically.

3.2 ANTHEM REMOTE APP OPERATION

The Anthem Remote App gives you full control of your MRX SLM and can be downloaded for free from the Apple or Google stores by looking it up using the keywords “Anthem remote”.

When starting the app, the welcome screen will show you available devices on the network. Select the MRX SLM will then show a screen with basic control such as volume and source/listening mode selection. Settings will give you access to the tone controls and various speakers level adjustments. Setup Menu will give you access to various system configuration settings.

More details about the setup that can be done via the app UI can be found in the SETUP (WEBUI & MOBILE UI) section.

3.3 WEB USER INTERFACE OPERATION

Controlling the MRX SLM can also be done using a browser on a device connected to the same network such as a smartphone, tablet or computer. The web interface lets you access the basic control as well as all system settings.

To access the MRX SLM web user interface, you will first need to identify the IP address of the MRX SLM. This can be found various ways, but the easiest are as follow:

Using the Anthem Remote App: When starting the app, the IP address of the unit will be shown in the opening screen. If the main screen is shown, simply click on “Discovery” to return back to the opening screen. Once you know the IP address of the unit, you can use a browser such as Safari or Google Chrome to access the web interface by typing the IP address into the URL bar.

Using File Explorer: If using a Windows PC, start File Explorer and click on “Network”. The MRX SLM will be shown under Media Devices. Double-clicking on the MRX SLM icon will open your web browser and will access the unit. The IP address will be shown in the URL bar that can be use in the future.

Using a network scanner: You can use a network scanner such as Fing or Angry IP to discover the MRX SLM IP address.

Using ARC Genesis: You can discover the MRX SLM IP address using the ARC Genesis software. Start the ARC Genesis program on a PC or Mac®, click on Launch ARC, and hover your mouse cursor over the MRX SLM, wait for a few seconds and a pop-up will show more details, including the IP address of the device.

3.4 TRADITIONAL REMOTE CONTROL OPERATION

Controlling the MRX SLM can also be done using the IR remote included in the accessory package.

- 1 – Power on
- 2 – LED - Flashes when a key is pressed. The LED stops flashing indicates that the batteries are not inserted properly or that the batteries are drained.
- 3 – Standby
- 4 – Mute
- 5 – Listening Mode
- 6 – Navigation Controls - The left/right buttons select the previous/next track. The center button acts as a Play/Pause button. The up/down buttons control the volume.

Input Source Selection

- 7 – Stream
- 8 – Bluetooth
- 9 – TV (ARC or eARC)
- 10 – Analog
- 11 – HDMI
- 12 – Digital (Optical)

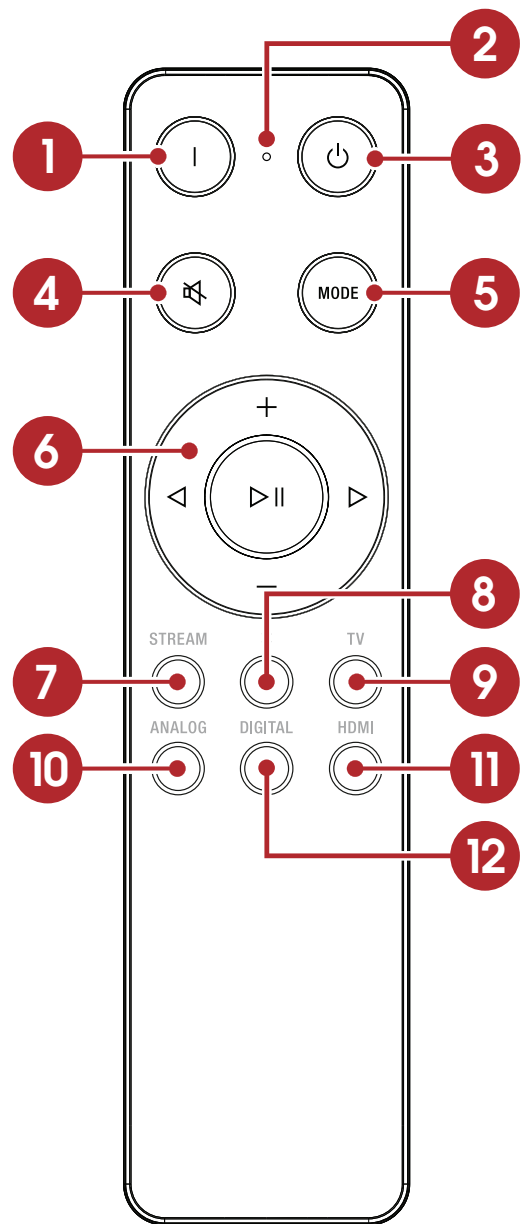

3.4.1 POWER ON / STANDBY AND VOLUME

The remote uses dedicated ON and Standby buttons to turn on and off the unit. When turning on the unit, the volume will be set to either a specific level or to the last volume value. This can be modified in the setup menu.

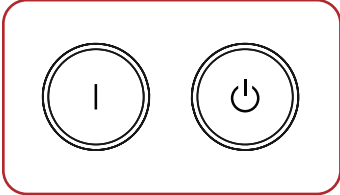

To control the volume, press the + and - on the remote navigation keys. To mute or un-mute the audio, press MUTE.

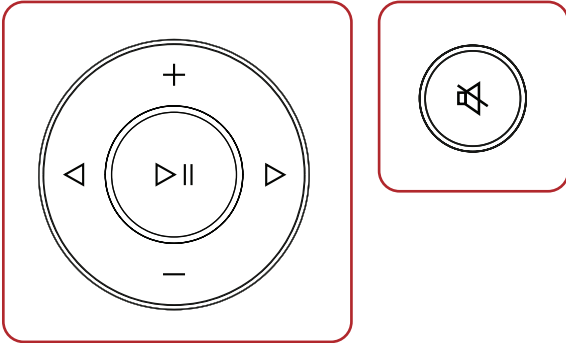

3.4.2 LISTENING MODES (MODE BUTTON ON REMOTE CONTROL)

Refer to the Input Setup section for a description of listening modes. If you wish, you can toggle to the next selection by pressing the MODE button.

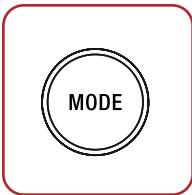

3.4.3 INPUT SELECTION

The number of active inputs varies according to how the Input Setup menu was programmed. By default, 6 inputs are defined and are mapped to the source keys on the remote. If more inputs are defined (up to 30 virtual inputs can be defined) pressing the source key another time will switch to the next virtual input using the physical connector. If a connector is used for more than one virtual input, pressing the remote source button another time will select the next virtual input which also makes use of this connector (and will eventually cycle around to the first one). If switching from a different source, the first virtual input making use of this connector will be selected.

For example, if you have defined a virtual input labeled “TV-late” (using the HDMI connector eARC/ARC for audio input and a speaker profile without a subwoofer), pressing the TV button the first time will be using the default TV input, but pressing it a second time will be using TV-late. If selecting another input (such as Digital), and then selecting TV will revert to the first input attached to your TV.

The STREAM input is automatically selected when starting the audio from your player, whether you are streaming via AirPlay, Google Cast or using an application such as Spotify. If the unit is in standby, it will turn on automatically.

The Bluetooth input (shown on the remote with the Bluetooth logo) works similarly, but pairing your device with the MRX SLM needs to be done once. Refer to the “Streaming via Bluetooth” section below for details.

When defining multiple virtual inputs, using the Anthem Remote App or the web interface is recommended for ease of use.

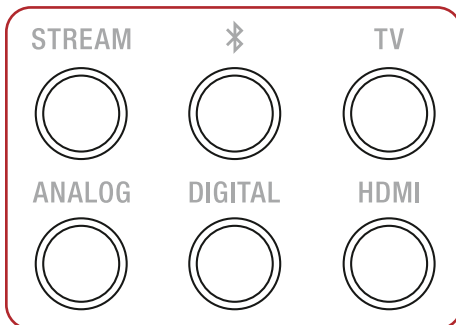

The MRX SLM factory defaults for the 6 inputs are configured as follow:

SOURCE	AUDIO INPUT	VIDEO INPUT
HDMI	HDMI	HDMI
TV (ARC/eARC)	TV (ARC/eARC)	None
Streaming	Streaming	None
Bluetooth	Bluetooth	None
Digital (Optical)	Optical	None
Analog	Analog	None

The virtual inputs that give you complete control of the name of each input you create, along with whether video (HDMI) will be used, which audio input (HDMI, digital, analog, streaming, or Bluetooth) to use, which speaker profile to use, and much more. For information on setting up inputs, refer to the Setup section of this manual.

3.5 STREAMING VIA AirPlay®

To listen to audio via AirPlay on your MRX, ensure your Apple device is connected to the same network as the MRX SLM and simply select it as the AirPlay audio playback device.

Note: The MRX will appear as the device name defined in the General Settings in the AirPlay speaker menu. The factory default for the MRX SLM name is “MRX SLM-xxxxxx” (where xxxxxx represents the last few characters of the LAN MAC ID, as shown at the back of the unit).

3.6 STREAMING VIA GOOGLE CAST



1. To listen to Cast audio from any supported application on your MRX SLM, ensure your device is connected to the same network as the MRX SLM via either a wired or wireless connection. Google Cast will also only work if the MRX SLM has been configured as a device using the Google Home app.
2. Tap the Cast icon from within the application and select the MRX SLM as the playback device. The factory default for the MRX SLM name is “MRX SLM-xxxxxx” (where xxxx represents the last few characters of the LAN MAC ID, as shown at the back of the unit).

STREAMING VIA SPOTIFY CONNECT

Use your smartphone, tablet or computer as a remote control for Spotify. Go to spotify.com/connect to learn how.

3.7 STREAMING VIA BLUETOOTH

Bluetooth connection requires both wireless antennas to be attached to the SLM and requires your device to first be paired. Select the Bluetooth input to enter pairing mode (the front panel power LED will flash blue). The front LED of the MRX SLM will start double-flashing indicating that pairing is in progress. Access the Bluetooth pairing screen on your device to select the MRX SLM and initiate the connection. Once the link is established, the front LED will turn back solid blue. The MRX SLM shown in the available Bluetooth devices will be advertised as the device name defined in the General Settings.

The factory default for the MRX SLM name is “MRX SLM-xxxxxx” (where xxxxxx represents the last few characters of the LAN MAC ID, as shown at the back of the unit). This pairing process need only to be done once.

Once paired, streaming audio via Bluetooth works the same as streaming using other method such as AirPlay or Google Cast. On your device, select the MRX SLM as the Bluetooth audio playback device and start streaming to it. The MRX SLM will automatically switch to the Bluetooth input and will even turn on if in standby.

Note that when you switch off your Bluetooth device, walk away or change inputs to a different source, the MRX SLM will lose the connection. The disconnection happens because Bluetooth was designed for individual speakers, and if it would automatically reconnect to the receiver, it can switch your input and play unwanted audio such as background audio from a website streaming on your smartphone.

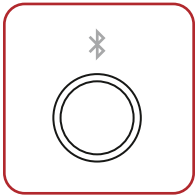

SETUP (WEBUI AND MOBILE UI)

Controlling and accessing setup parameters of the MRX SLM can be done using a browser on a device connected to the same network such as a smartphone, tablet or computer. To access the MRX SLM web user interface, you will first need to identify the IP address of the MRX SLM. Refer to the OPERATION section for details.

The Anthem Remote App can also be used to access the mobile UI. The app does not need any IP address and will discover the MRX SLM on your network. Setup can be done by clicking on Settings and then accessing the Setup Menu.

4.1 INFORMATION PAGE

WEBUI info page is accessed by clicking on the icon of the MRX SLM from the left toolbar, this page is used for viewing information about your MRX SLM's hardware and software versions as well as network, system status and copyrights. No information can be changed here, just viewed.

MOBILE UI info page is accessed by clicking on the Anthem logo on the top left corner of the Setup Menu screen. This page is used for viewing basic information about your MRX SLM's and app software versions. No information can be changed here, just viewed.



INFORMATION

View general information about your MRX SLM, including firmware versions and serial number.

NETWORK MODULE

View all network related information.

SYSTEM STATUS

View all information related to incoming audio and video signals. Note that this section displays what is being sent as a description, and can be potentially incorrect.

COPYRIGHTS

View copyrights of open source projects.

4.2 QUICK ACCESS

Quick access to the volume, source selection, listening mode, tone control and speaker trims are shown in a single page for the web UI. The Anthem Remote App splits this in 2 screens: the tone control and speaker trims are accessed by clicking on Settings. Access to the Setup Menu via the app is also done by clicking on Settings.

MAIN ZONE

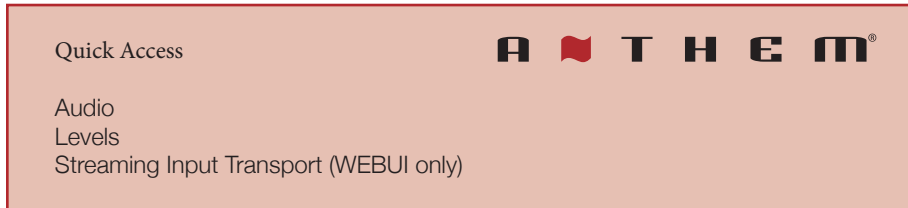

AUDIO

Control the basics of your MRX SLM from this page. Power On/Off, change volume and inputs from here.

LEVELS

Set levels for individual speakers, as well and/or tone controls such as Balance, Treble and Bass.

STREAMING INPUT TRANSPORT (WEBUI ONLY)

Control playback when Streaming input is active. Allows for various playback modes (normal, shuffle, repeat, etc), and transport controls. This option will only appear in the Main Zone window when the current input is set to Streaming or Bluetooth.

4.3 SYSTEM SETUP – GENERAL SETUP



GENERAL SETTINGS

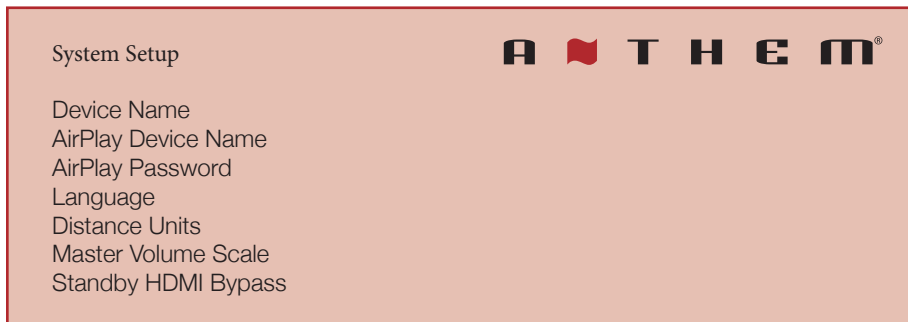

DEVICE NAME

Allows you to change the name of the unit. This will also help to identify units in ARC and different streaming platforms. The factory default for the MRX SLM name is “MRX SLM-xxxxx” (where xxxxx represents the last few characters of the LAN MAC ID, as shown at the back of the unit).

AirPlay DEVICE NAME

Displays the unit's AirPlay name. *This appears ONLY when the device is renamed through Apple HomeKit®.*

AirPlay PASSWORD

Set the optional password to access the device through AirPlay.

LANGUAGE

Set the language you would like the web user interface to appear in.

DISTANCE UNITS

Choose between imperial and metric versions of measurement.

MASTER VOLUME SCALE

By default, this is set to "dB" which is common for most modern receivers. "dB" references the volume trim of the incoming signal where "0.0 dB" is the unaltered signal coming in from a source. While this is the standard, it can be confusing for new users. "%" offers a volume scale of 0-100, which is standard for computers, televisions and most sources.

STANDBY HDMI BYPASS

Passes the HDMI input directly to the display while the unit is in Standby mode.

POWER SAVING



NO SIGNAL POWER OFF

When there is no input signal, the MRX SLM turns off after the selected time: 5, 10, or 20 minutes, 1, 2, or 6 hours, or "Never." The default setting is 20 minutes.

FRONT PANEL LED BRIGHTNESS

Set the brightness of the front indicator from maximum to dim or completely off.

MAIN ZONE

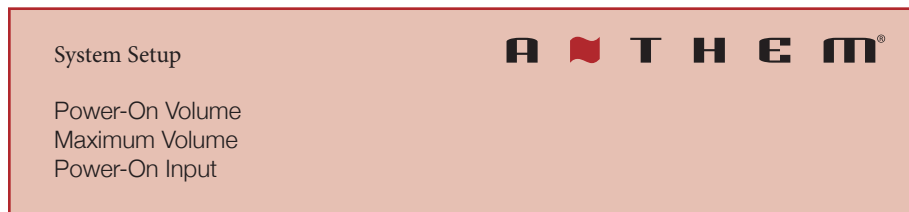

POWER-ON VOLUME

This setting controls the volume level to use when powering on the MRX SLM from standby mode. To power-on at the last used volume, select “Last Used” by changing the value to less than -90.

MAXIMUM VOLUME

This setting allows you to limit the maximum volume output of the MRX SLM to avoid damaging equipment or hearing.

POWER-ON INPUT

This setting controls which input to use when first powering on the MRX SLM. Select from one of the available inputs or “Last Used.”

CEC SETTINGS



CEC CONTROL

With CEC enabled, Consumer Electronics Control (CEC) allows controlling an HDMI-connected component using another brand’s remote control (as long as the other components have CEC enabled). Note that when components are from different brands, this control system may not be reliable.

CEC Control must be enabled if ARC or eARC are utilized. Note that CEC Control is disabled by default and that reloading factory defaults will turn it off.

With CEC, turning on (or off) one component in the system can turn on (or off) the rest of the system. You may or may not want this, which is why we provide separate options for CEC Power Off Control. When either setting is disabled, the MRX SLM ignores corresponding power Off commands sent by other HDMI-connected components.

CEC POWER-OFF CONTROL

Allows connected devices to set the MRX SLM in standby mode.

4.4 SYSTEM SETUP – SPEAKERS SETUP

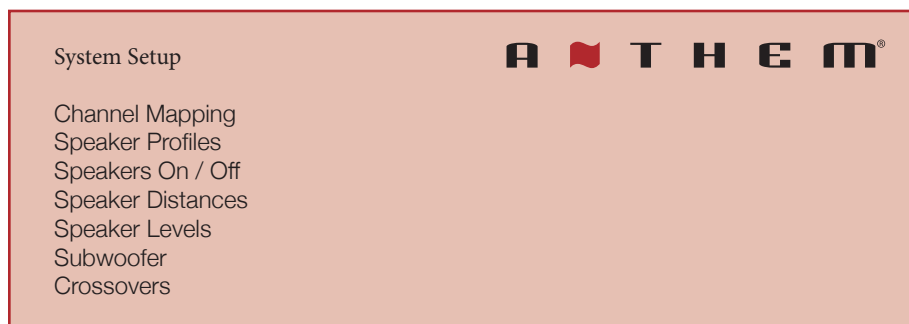

CHANNEL MAPPING



AMP MATRIXING

Amp matrixing is where you assign the surround channels to their desired function.

1. Select amp matrixing for surround speakers for a standard 5.1 speaker configuration.
2. Select Front (Bi-Amp) to use the surround channels to drive your fronts L/R speakers in bi-amp mode.
3. Select any of the other speaker configuration (e.g. Front In-Ceiling or Front Dolby) if using a 3.1.2 speaker configuration.

When the surround channels have been re-mapped to a different channel, the name of the actual channel will be shown. For example, if Dolby Front has been selected for the surround output, when setting the distance, level or crossover the label "Surround" will be replaced by "Front Dolby" in the user interface. For ease of readability, the manual refers to Surround in the Speakers Setup section.

Note that the function of the surround channels applies to all 4 channel profiles.

SPEAKER PROFILES (1-4)

The use of one speaker profile is suitable for most systems. However, the MRX SLM allows up to four unique profiles with unique speaker selections, bass management, listening position, level calibration, and Anthem Room Correction (ARC) equalization values. Multiple speaker profiles are useful if your listening room varies according to predictable sound-altering characteristics such as screen up versus down, a door open versus closed, or stereo listening for music vs. home theatre.

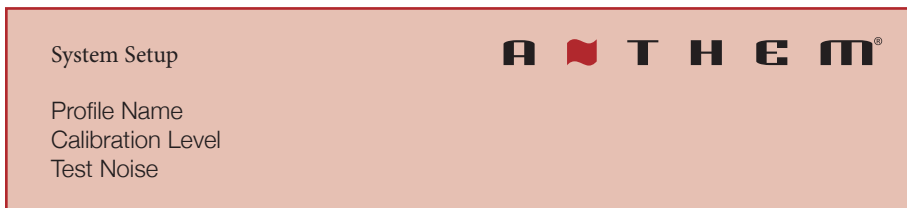

PROFILE NAME

Each profile can be renamed, with up to 64 ASCII characters, fewer if other-language letters with accents are used.

CALIBRATION LEVEL

This setting adjusts the volume for this menu's test noises. It changes the output of all channels.

TEST NOISE

To play the test noise, use the pull-down menu to select the desired channel or None to turn it off. While the test noise is playing, you can balance the level of individual channel by adjusting them in the Levels (see below).

SPEAKERS ON / OFF

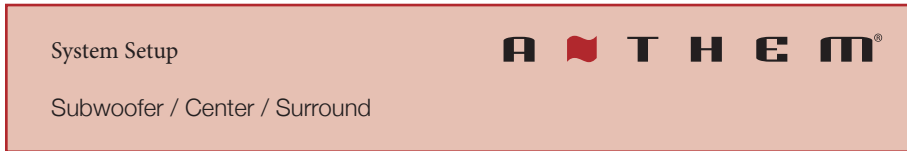

SUBWOOFER / CENTER / SURROUND

Activate output to the speakers, note that the Front Left/Right cannot be turned off. The subwoofer output will not function unless it has been indicated that a subwoofer is present. If using a subwoofer, this should be enabled prior to running ARC.

SPEAKER DISTANCES

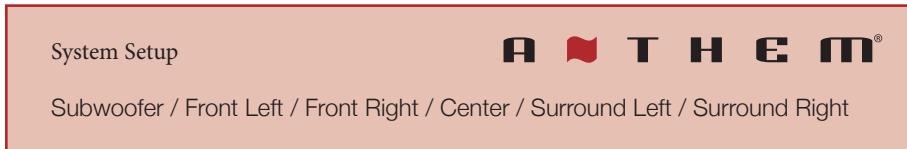

SUBWOOFER / FRONT LEFT / FRONT RIGHT / CENTER / SURROUND LEFT / SURROUND RIGHT

Adjust the distance from the primary listener position to individual speakers. If running ARC, let it set the distances for you.

SPEAKER LEVELS

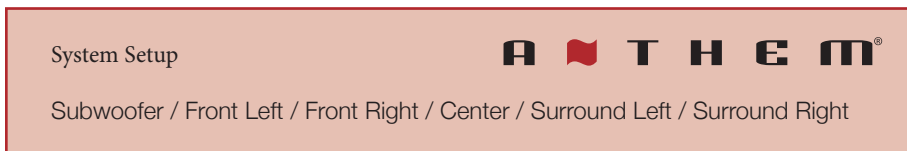

SUBWOOFER / FRONT LEFT / FRONT RIGHT / CENTER / SURROUND LEFT / SURROUND RIGHT

If you're calibrating by ear, use the webUI, and sit in the listening area. Adjust each channel's loudness until all levels sound the same. If using an SPL meter, adjust the level until it reads 75 dB for each channel. If Front Left was at 0dB when you set Calibration Level, then no adjustment of Front Left is necessary. If using a powered subwoofer, adjust the sub's built-in level control before setting the subwoofer level in this menu or using ARC. Speakers set to "Off" in the Bass Management menu can not be adjusted. Note that if ARC has been used to set levels and is then turned off, the subwoofer level should be reduced by the same amount as room gain, or else you'll hear elevated subwoofer output.

SUBWOOFER

System Setup	A T H E M [®]
Phase Frequency	
Phase	
Polarity	

PHASE FREQUENCY

Phase Frequency allows you to select at which frequency the phase shift is applied (generally the same frequency as the crossover).

PHASE

Adjusts the phase of the subwoofer relative to the main channels. Phase is adjustable from 0-180 degrees. If a value higher than 180 degrees is required, adjust Subwoofer Phase in combination with Sub Polarity for a full 360-degree range of adjustment. When using ARC, this value is automatically set using the Automatic Phase Adjustment tool.

POLARITY

Adjusts the polarity of the subwoofer to either 0 or 180 degrees. When selecting 180 degrees, the subwoofer signal is inverted when compared to the main channels. As a general guide, set Phase and Polarity to 0 if the subwoofer is near the front speakers and set Phase to 0 and Polarity to 180 if the subwoofer is near the back of the room. When using ARC, this value is automatically set using the Automatic Phase Adjustment tool.

CROSSEOVERS

System Setup	A T H E M [®]
LFE Low Pass Filter	
Front, Center and Surround Crossover	

LFE LOW PASS FILTER

Sets the Low Pass Filter (LPF) frequency for Low Frequency Effects (LFE).

FRONT, CENTER AND SURROUND Crossover

Sets the crossover point between the subwoofer channel and the selected speaker(s). This value will be set by ARC. If the crossover value changes to a number other than the default selected by ARC, you must modify the crossover setting in ARC and recalculate and upload. These crossover values should only be adjusted if ARC has not and will not be run.

4.5 SYSTEM SETUP – INPUTS SETUP

The MRX SLM has by default 6 inputs but up to 30 virtual inputs can be defined. This allows you to quickly change a number of parameters by simply selecting an input. For example, you may want to create a late night listening mode by selecting a speaker profile with no subwoofer and Dolby Audio Post-Processing set to Night mode.

System Setup



- Insert Before Input
- Add Input
- Delete Input
- Input Name
- Video Input
- Audio Input
- Speaker Profile
- Audio Mode Preset
- Anthem Room Correction
- Dolby Audio Post-Processing
- Dolby Speaker Virtualization
- Dolby Dynamic Range Control
- DTS Dynamic Range Control
- DTS Dialog Normalization
- Lip Sync
- Input Trim

INSERT BEFORE INPUT

Create a new input, and specify its location within the input list.

ADD INPUT

To add a new input at the end of the list, highlight and press "Add Input".

DELETE INPUT

To delete an input, click on the X on the top right corner and click on OK to confirm. Note that the currently selected input CANNOT be deleted.

INPUT NAME

Each input can be renamed, with up to 64 ASCII characters, fewer if other-language letters are used.

VIDEO INPUT

Select whether HDMI video will be enabled or not.

AUDIO INPUT

Select the connection to use: HDMI, TV (ARC/eARC), Streaming, Bluetooth, Digital (Optical), Analog or None.

If HDMI is selected as the Video Input, the only possible option for the Audio Input is HDMI.

When an audio source is selected for more than one virtual input, pressing the remote control source button multiple times may be required to select the desired virtual input. Refer to section 3.4.3 INPUT SELECTION for more details.

SPEAKER PROFILE

Select the profile to use with this input. This is where you can select previously made speaker profiles for different situations, such as 5.1 vs. 2 channel.

AUDIO MODE PRESET

A listening mode is processing that enhances source material by increasing the number of output channels. Each available mode performs this differently, providing a unique type of sound. To find your preference, spend some time listening to various modes using various sources. To disable presets and make selections entirely on the fly, select “Last Used.” To disable listening modes altogether, select “None.”

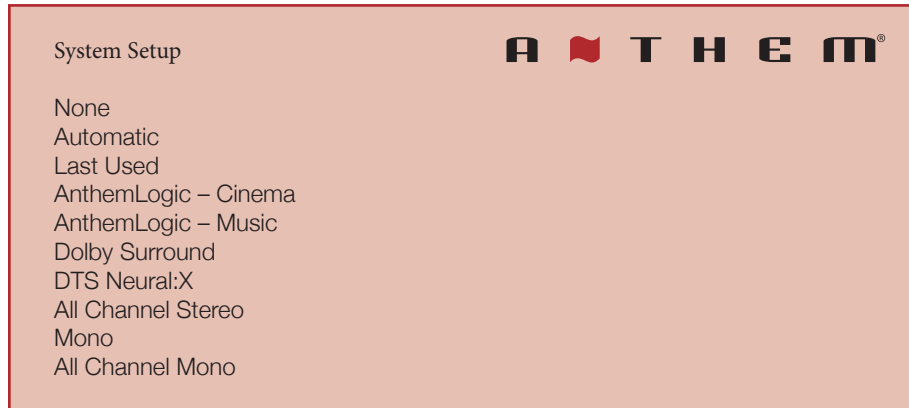

NONE

When the Audio Mode is set to None, no up-mixing is applied.

AUTOMATIC

When set to Automatic, Dolby Surround will be selected when Dolby encoded material is received and DTS Neural:X will be selected for DTS encoded material, otherwise None will be selected.

LAST USED

When set to Last Used, the Audio Mode that was in effect the last time you have selected this input will be re-applied.

ANTHEMLOGIC – CINEMA

AnthemLogic-Cinema lets you experience full impact home theater sound from any 2-channel source. This mode creates an extensive, enveloping, and dynamic listening experience, making 2-channel movies sound more like a state-of-the-art movie theatre. Through extensive listening tests, Anthem engineers developed this proprietary mode avoiding the use of echo effects, which could negatively affect the purity of the sound.

ANTHEMLOGIC – MUSIC

AnthemLogic-Music enhances the stereo listening experience without detracting from the stereo soundstage. This mode is also a minimalist design that uses no echo or reverberation effects. To ensure that the purity of the stereo music soundstage is not compromised when you're sitting in the "sweet spot" listening to your favorite stereo recordings, this mode uses no center channel.

DOLBY SURROUND

Dolby Surround up-mixes all stereo, 5.1, and 7.1-channel content to take full advantage of all speakers in a Dolby Atmos system. Unlike previous wideband upmixing technologies, Dolby Surround can steer frequency bands individually, producing surround sound with precisely located audio elements and a spacious ambiance. Dolby Surround replaces the Dolby Pro Logic II family of upmixers, offering greater flexibility and superior audio performance.

DTS NEURAL:X

DTS Neural:X is an upmixer using a spatial remapping engine to deliver pristine audio and provide immersive audio experience by making use of the speakers defined in your speaker profile.

ALL CHANNEL STEREO

All Channel Stereo mode sends the left and right channels to the surround channels with equal loudness while the center channel and subwoofer receive a combination of both.

MONO

MONO sums all the channels and sends it to the center channel. All other channels are muted.

ALL CHANNEL MONO

All Channel Mono sums all channels and distributes an identical signal across all speakers. The only difference between each signal speaker will be determined by their crossover setting and therefore how much bass each will play.

ANTHEM ROOM CORRECTION

The ARC measurement process, described later, automatically turns this On. To disable room equalization afterward, change this to “Off.” If room correction isn’t loaded, “N/A” is displayed. This toggle is only available after performing a room calibration with ARC Genesis.

DOLBY AUDIO POST-PROCESSING

Select “Music”, “Movie”, “Night” or “None.” Dolby Volume makes content with significant differences in volume easy to listen to by analyzing it and intelligently adjusting two things—level and frequency response. It does this continually without causing pumping and breathing artifacts that are common with traditional dynamic range compressors. In doing so, the volume setting is taken into account, as is our hearing’s declining sensitivity to the lowest and highest frequencies relative to the midrange as their levels drop. The result is that the perceived frequency response remains constant while making quieter parts of the content more listenable.

DOLBY SPEAKER VIRTUALIZATION

Enable Dolby Atmos Height Virtualization to create the sensation of overhead sound from the listener-level speakers. For stereo and 3.1-channel speaker configuration, Dolby Atmos height virtualization is combined with surround virtualization to create an enveloping 360-degree audio minus the speakers that would ordinarily be employed behind or to the side of the listener.

DOLBY DYNAMIC RANGE CONTROL

When disabled, the signals are played back at the original volume: quiet signals remain quiet and loud signals remain loud. Enabling DDR compresses the volume difference and increases the overall volume. The audio is easier to hear, regardless of the dynamic range of the sound source. When set to Automatic, the encoding of the input signal is used to determine which processing to use.

DTS DYNAMIC RANGE CONTROL

Similar to Dolby DRC by minimizing the volume differences, but offers 2 levels that can be selected: medium and maximum.

DTS DIALOG NORMALIZATION

Adjust the sound level to compensate for Dolby vs DTS encoded material.

LIP SYNC

If you hear the audio before seeing its corresponding image, you can set up to five hundred (500) milliseconds of audio delay. Set this using trial and error or, a synchronization test disc. Movies are not always the best test because sounds, including dialog, are usually re-recorded after the filming is completed, and can be slightly out of sync at various points in the recording.

INPUT TRIM

If your inputs have varying degrees of volume output, you can normalize them by setting your input trim per input. This offers both + and - options for input trim, but it is recommended to set your quietest input at 0.0 dB and normalize your louder ones around that by trimming them down.

As an example, if you find the streaming services are louder than the analog input, adjust the Streaming input trim level down to the level of the analog input level.

4.6 SYSTEM SETUP – NETWORK SETUP



NETWORK / CONTROL



TCP PORT

Allows you to change the TCP Port number. Only values between 1025 and 49150 are accepted. Note that this should only be changed if there is a conflict on the network with another component.

IR

Select whether the IR signal from the remote control is decoded using the Front IR receiver or the Rear IR jack. When selecting Rear IR, make sure to connect the IR extender cable (included in the accessories) in the jack labeled IR EXTENDER IN located beside the AC inlet.

IP STATUS

Displays the status of the current network connection, IP mode, IP address as well as the subnet, gateway and DNS.

ETHERNET CONFIGURATION

Settings in this submenu should only be changed if you want to use a static IP address and want to define the subnet, gateway and DNS.

If errors occur when adjusting the unit's static IP settings, the MRX SLM can be manually set back to AUTO DHCP. This will remove the manually set IP settings, return the unit to Auto DHCP and allow the unit to be re-connected to the network. To perform this action, on the back of the unit depress the DHCP Reset button with either a pin or a pen and hold the button in for between 2-5 seconds. The unit will be available to reconnect to the network within 30 seconds.

The MRX SLM will retain its current name if it has been changed, either by the user, Apple and/or Google Home Applications. If using a Wi-Fi connection either through an iOS or Android device the user can set up the device again through WAC mode (iOS device) or through Google Home. If the user has a password protected Wi-Fi network, they will be prompted to enter the password to rejoin the Wi-Fi network.

If using an ethernet connection, depressing the DHCP reset button for 2-5 seconds will also return to Auto DHCP and the unit will obtain new settings from the router.

*No changes will take effect until the "Apply" button is clicked.

Wi-Fi CONFIGURATION

Settings in this submenu lets you connect to a wireless network manually. Click on Scan to start populating the available networks that will be shown in the SSID pull-down. Type in the Password and click on Apply to configure the MRX SLM. Alternatively, you can toggle the Manual SSID button and enter the SSID network name. Once the LAN cable will be disconnected, the unit will connect to the wireless network automatically.

If you don't have a LAN cable, you can setup the wireless network by using the Google Home application or via AirPlay. Refer to the OPERATION section for details on how to do this.

*No changes will take effect until the "Apply" button is clicked.

4.7 SYSTEM SETUP – STORE / LOAD / UPDATE



STORE / LOAD SETTINGS

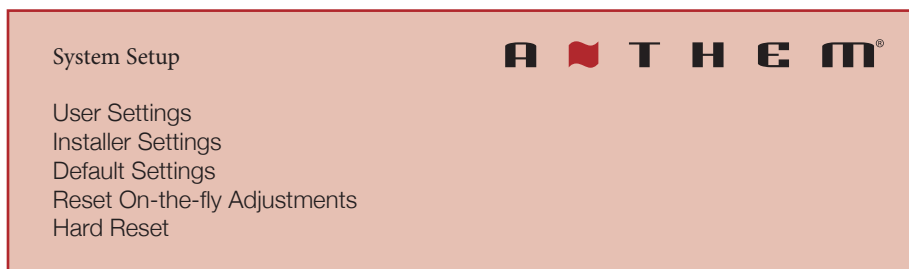

USER SETTINGS

Selecting Store User Settings and confirming saves all menu settings in a built-in “user file”. If you change settings later and want to recall the saved settings, select Load User Settings.

INSTALLER SETTINGS

This offers the same functionality as the Store / Load user settings, but offers you a second option for an installer to save their settings when they leave. This can be useful if user settings are modified to a point where there are issues, so they can revert back to the settings where the installer last left them.

DEFAULT SETTINGS

Selecting and confirming this option resets all menu settings to the factory defaults. This option does not reset network settings.

RESET ON-THE-FLY ADJUSTMENTS

Selecting and confirming this option resets all non-menu settings such as level and bass/ treble.

HARD RESET

Resets all persistent and on-the-fly settings. Communication with the device will be lost if a wireless connection is used as the Wi-Fi settings are cleared. This will also clear all AirPlay and Google Cast configurations. If the unit was previously added to the Apple or Google Home applications, it would be best to remove the device, (if listed in the Home application) and re-add the MRX SLM once the hard reset is done.

The current configuration of the unit (such as names, trims, speaker profiles or Anthem Room Correction) will revert to the factory defaults. User and installer settings will also be replaced by the factory defaults. If you want to preserve your settings, use the export/import features.

The software/firmware version will be retained on the unit and the name of the unit will revert back to MRX SLM-xxxxxx, (where xxxxxx represent the last characters of the LAN MAC address).

A hard reset can also be done by pressing and holding the DHCP Reset/Factory Reset button (located beside the AC inlet) for 6 to 10 seconds.

EXPORT / IMPORT SETTINGS



EXPORT SETTINGS

Creates a file that can be saved on your PC or mobile device allowing you to copy settings to another MRX SLM or in the event of a replacement unit or service, this file can be used to reload the settings.

IMPORT SETTINGS

Allows you to upload a file of settings that you have previously created either from this unit or another MRX SLM.

FIRMWARE UPDATE

Firmware updates (whether beta or fully-released versions) will preserve your settings and ARC parameters.



BETA UPDATES

When selected, your MRX SLM will become enrolled in our beta over-the-air receiver update program that provides updates to help with testing new software, which will either include bug fixes or new features.

Note that beta updates are not necessarily ready for full release and may introduce new bugs into your MRX SLM (which can be resolved by reverting to the old software or waiting for the newer version of the beta software) if you are not comfortable with potential bugs, leave this setting at its default position. A check for a beta update is automatically performed once a day. This option requires an internet connection.

CHECK FOR UPDATE

When you select this option, it will scan for a software update and prompt to update if one is found. Note that the newest software will be selected; if you have "Beta Updates" enabled, this file can be a beta or full release firmware version. This option requires an internet connection.

ANTHEM ROOM CORRECTION

5.1 ANTHEM ROOM CORRECTION (ARC®)

Please visit AnthemARC.com for detailed information about using Anthem Room Correction.

The most significant detriment to the sound of an audio system is almost always the room it resides within—especially true in the realm of bass. Even in a professionally treated sound room, bass can quickly become boomy or anemic. Anthem Room Correction helps audio systems sound their best in any space. ARC offers a robust suite of tools to tame your wild sonic frontier—whether you have a tricked-out home theater, a traditional living room with carpet and thick drapes, or a modern floor plan with large open spaces and acoustically reflective furniture and windows.

Have you ever tested the acoustics in an empty room by whistling or clapping? It brings to mind how sound is affected by a room's size, structure, and contents. Even when using optimally positioned speakers of exceptional quality, the room negatively impacts sound quality considerably. Surfaces such as windows and furnishings and the geometry of the walls, floor, and ceiling add unwanted resonance and coloration, making the bass either boomy or less punchy, voices less natural, and dialogue less intelligible. The effect on frequency response is typically ± 6 dB in the midrange and ± 10 dB at low frequencies.

To compensate for this and to optimize the in-room response of your speakers, Anthem Room Correction measures the output of each speaker relative to the listening area then, through a series of calculations, adjusts its output. Not only does ARC correct peaks and dips in a speaker's frequency response, but it also preserves the beneficial acoustic attributes of a room—attributes based on proven psychoacoustic science (the study of how humans hear and experience sound).

In the sample curves provided here, the red curves represent the in-room response before correction, as an average from five measurement positions. In contrast, the green ones show a response with equalization applied. The black curve represents the target response. In this case, a subwoofer and bass management are also in use.

The default correction range, as shown below, is 5,000 Hz. This range can be changed to a higher or lower frequency if desired, although raising it is not recommended. At higher frequencies, the microphone becomes directional, thus affecting measurement accuracy. Note the rise in the measured and corrected response below 200 Hz. This rise shows the amount of room gain. ARC preserves the natural room gain of the room or allows you to adjust the amount of room gain if you wish.

The subwoofer graph may imply that the subwoofer plays up to the highest frequency shown, but what it plays depends on what the other channels send to it as determined by their crossover setting. The subwoofer graph shows the available correction range, which is not necessarily the range that other channels send to it through bass management.

5.2 USING ARC WITH THE MRX SLM

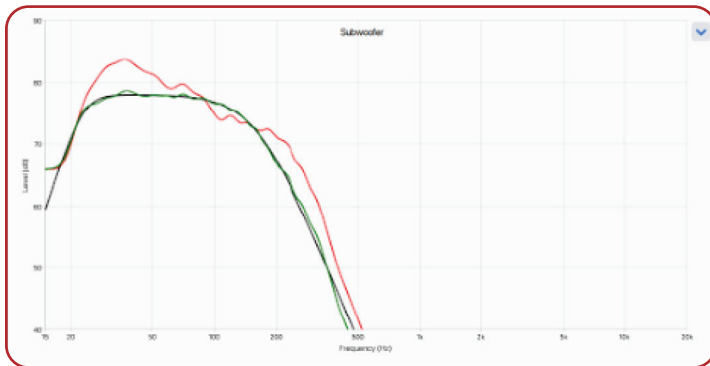
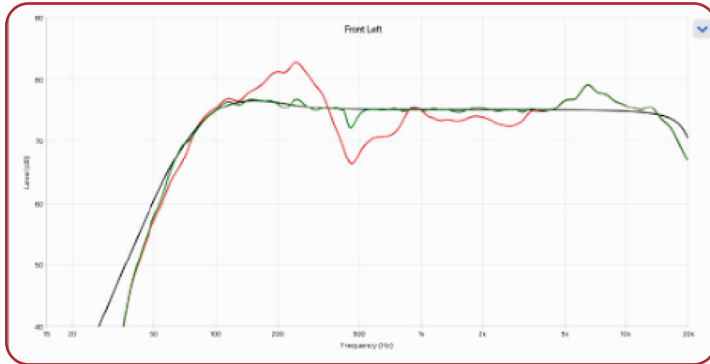

In addition to correcting the acoustic response of subs and speakers, ARC also:

- Adjusts the overall balance of the speakers.
- Sets the crossover point between the speakers and subwoofer (do not manually change this after running ARC).
- Adjusts the speaker's distance.
- Adjusts the subwoofer's level relative to the speakers.
- Adjusts the subwoofer's phase/polarity relative to the speakers.

When using ARC Genesis, the speakers will output very loud sounds during the room correction process and as the volume cannot be adjusted, please be considerate of housemates, neighbors, children and pets who are in the area.

Before using Anthem Room Correction make sure to connect and enable your subwoofer (if applicable).

To use Anthem Room Correction:

1. Download and install the program from AnthemARC.com.
2. Start the program and select Launch ARC from the first screen.
3. Select the MRX SLM from the device discovery screen.
4. Follow the on-screen instructions to measure the room, calculate correction curves, and upload them to the MRX SLM.

1. Google Home does not seem to discover my MRX SLM. Any recommendations?

Google Home uses Bluetooth to discover new devices. Make sure that both wireless antennas are connected at the back of the MRX SLM. It is good practice to set them orthogonal to each other to improve reception. Make sure that your device is also nearby the MRX SLM for the initial Google Home setup.

2. When using Google Home to connect my MRX SLM to my wireless network a warning is telling me that the MRX SLM may not be compatible with my Wi-Fi network. Should I ignore this message?

The simple answer: yes ! Depending on your country, some wireless channels may not be available and this is why the app is showing you this warning. But as there are several other channels, your device you are using to control or stream to the MRX SLM will simply be using an available channel for your country when connecting to the receiver.

3. How can I change the speaker configuration in the setup menu as everything is grayed?

To change any parameter in the setup menu, the unit needs to be in operate mode. Simply turn on the unit by toggling the power in the the Main Zone screen.

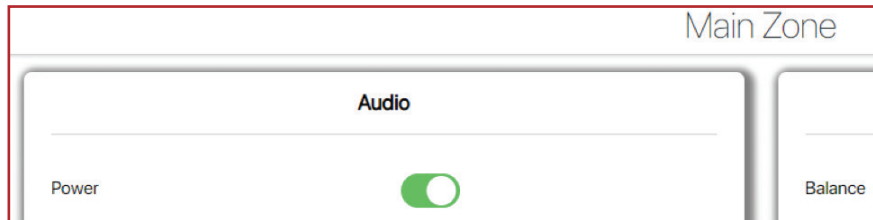

4. When selecting TV, I hear no audio from the SLM - why?

There are a number of reasons why getting audio via ARC (Audio Return Channel) or eARC (enhanced Audio Return Channel).

- Make sure your TV supports ARC or eARC. Some older TVs may not support the audio return channel.
- Ensure the cable is connected into the HDMI port on the TV that supports ARC/eARC. TVs usually have multiple HDMI inputs, but typically only one of these will support ARC/eARC.
- Make sure that the HDMI cable between the TV input and MRX SLM output supports eARC (i.e. HDMI cable with ethernet) if this is the audio format you want to use.
- Go in the setup menu of the TV and make sure that the preferred audio output is set to ARC/eARC.
- If using ARC or eARC, CEC must be enabled on both your TV and the MRX SLM. Go in the General Setup menu of the MRX SLM and turn ON CEC Control. Note that by default, CEC is disabled on the MRX SLM.
- On some TVs, disabling and re-enabling ARC/eARC may be required for audio to actually start working.

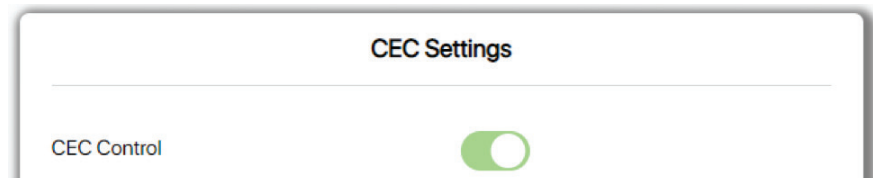

5. I have connected the IR extender cable at the back of the MRX SLM, but it does not seem to be working?

To use the IR extender cable you need to go in the Network Setup menu and select the rear IR. You cannot turn the front and rear IR inputs at the same time.

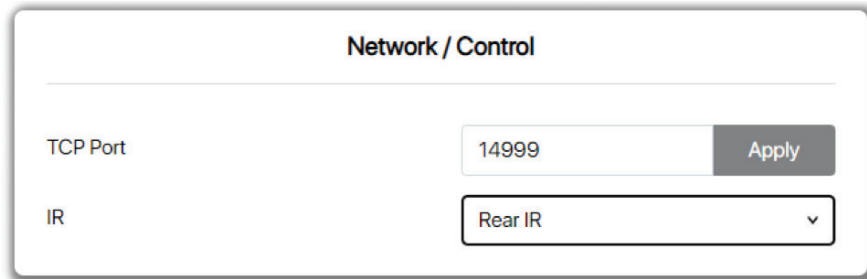

The screenshot shows a web interface titled "Network / Control". It has two rows of settings. The first row is labeled "TCP Port" and has a text input field containing "14999" and an "Apply" button to its right. The second row is labeled "IR" and has a dropdown menu with "Rear IR" selected and a downward arrow icon.

6. I'm sending commands to the MRX SLM using the TCP or WebSocket, but the MRX SLM does not react.

Make sure to send the terminator ";" at the end of the command. CR/LF is not required.

7. I've unplugged the LAN cable after configuring the wireless network, but I am no longer able to communicate with the MRX SLM. Plugging back the LAN cable, everything works OK. What I am doing wrong?

When switching from ethernet to a wireless network, the IP address will likely be a new one and this is why you are losing control of the unit. If using the Anthem Remote App, go back into the discovery screen or re-start the app and re-connect to your MRX SLM. If using the web interface, use one of the method described in section 3.3 to find out the new IP address.

8. Some things just don't work! Can I get help?

Try doing an AC cycle (unplug AC, wait a minute or so and re-apply AC power) and while the unit is OFF, verify that your cables are connected properly and are in good condition. You may also want to do the same with your TV and source devices.

Before contacting customer support, please ensure that the SLM firmware is up to date as we continuously strive to make improvements to the software. This can be done by accessing the Store/Load/Update page and by clicking on Check for Update.

You can also look at our online FAQ <https://faq.anthemav.com/support/home>.

If still experiencing issues, support can be reached by sending an e-mail at support@anthemav.com.

SPECIFICATIONS

SPEAKER OUTPUT (0 DBFS DIGITAL INPUT, 1 W OUTPUT INTO 8 OHMS)

Frequency Response	20 Hz - 20 kHz +/-0.5dB
S/N Ratio (IEC-A filter)	> 92 dB
THD+N ratio (1 kHz, 20-22 kHz filter)	< -87 dB

SPEAKER OUTPUT (1 VRMS ANALOG INPUT, 1 W OUTPUT INTO 8 OHMS)

Frequency Response	20 Hz - 20 kHz +/-0.5dB
S/N Ratio (IEC-A filter)	> 88 dB
THD+N ratio (1 kHz, 20-22 kHz filter)	< -85 dB

SPEAKER IMPEDANCE

Compatible with 4 Ohms or higher impedance.

MAXIMUM CONTINUOUS OUTPUT (0.1% THD)

Channels 1-5, Two Driven into 8 Ohms	50 W
Channels 1-5, Two Driven into 4 Ohms	92 W

POWER CONSUMPTION

Typical Load (1/8th power, all channels driven into 8 ohms)	< 50 W
Standby (IP Control Enabled)	< 2 W
Standby (IP Control + HDMI Bypass Enabled)	< 5 W

DIMENSIONS

Height (without feet)	1.5" / 3.8 cm
Height (with feet)	1.7" / 3.8 cm
Height (with rackmount kit)	1U / 1.75" / 4.4 cm
Width	11" / 27.9 cm
Width (with rackmount Kit)	19" / 43.2 cm
Depth	11" / 27.9 cm
Depth (including power cord)	13" / 33.0 cm

WEIGHT

6.6 lb / 3.0 kg

POWER REQUIREMENT

120 V version	In countries where the line voltage is 120 V, this product operates from a single phase AC power source that supplies between 108 V and 132 V at a frequency of 60 Hz.
220-240 V version	In countries where the line voltage is 220, 230, or 240 V, this product operates from a single phase AC power source that supplies between 198 V and 264 V at a frequency of 50 Hz.

LIMITED WARRANTY

CANADA & USA

The warranty period on new Anthem products is:

5 years: Separate power amplifiers and integrated amplifiers

3 years: Audio/Video preamplifiers and receivers

Please register your product at www.anthemAV.com

The warranty period begins on the date of purchase from Anthem or an Authorized Anthem Dealer. This warranty is offered only to the original owner and is not transferable. Demonstration and display units are covered by the same warranty except that the period commences on the date of dealer invoice, not the purchaser's invoice, and cosmetic flaws are excluded.

If Anthem determines that the product has a defect in materials or manufacturing during the warranty period Anthem will at its option repair, replace or provide the necessary replacement parts without charging for parts or labor. Repaired or replaced equipment or parts supplied under this warranty are covered by the unexpired portion of the warranty.

Warranty is void if the serial number has been removed, altered or defaced, if the product has been operated, installed or handled other than in accordance with the intended application, tampered with, modified, or damaged by accident, while in transport or by failure of electric power, or has been repaired by a non-authorized party. Anthem shall have no obligation to correct any defect that is not reproducible by Anthem. If inspection by Anthem discloses that the repair required is not covered by this warranty, regular repair charges shall apply.

If a problem is discovered in your Anthem product, please contact the Authorized Anthem Dealer from whom you purchased the product. Your dealer will help to determine the cause of the problem and arrange for the appropriate action. Alternatively, follow the procedure below for factory service.

A Return Authorization (RA) number must be obtained from Anthem Technical Support before a product can be shipped to Anthem for any reason. Product shipped to Anthem without its RA Number clearly visible on the outside of the shipping carton will be refused and returned to the sender, freight collect. Product shipped to Anthem must have shipping and insurance prepaid by the sender, be packaged in the original carton and packing material and accompanied by a written description of the defect. Service will not be given under warranty without an accompanying copy of the sales invoice. Product repaired under warranty will be returned with shipping and insurance prepaid by Anthem (within Canada and continental USA only).

DISCLAIMER OF LIABILITY

Under no circumstances shall Anthem, its agents, representatives or employees assume liability or responsibility for injury or damages sustained in the use or operation of Anthem products or for damages to connected products. Some jurisdictions do not allow limitations of incidental or consequential damages so this exclusion may not apply to you.

Anthem reserves the right to make design changes without obligation to revise prior versions. All specifications are subject to change without notice.

This warranty shall be the sole and exclusive remedy to you. No other warranty or condition, statutory or otherwise, expressed or implied, shall be imposed upon Anthem nor shall any representation made by any person, including a representative or agent of Anthem, be effective to extend the warranty coverage provided herein.

On the expiration of the warranty all liability of Anthem in connection with the product shall terminate.

INTERNATIONAL

Terms and conditions are set and maintained by the Authorized Anthem Distributor, not Anthem.

THE BIG PICTURE MRX SLM FRONT PANEL

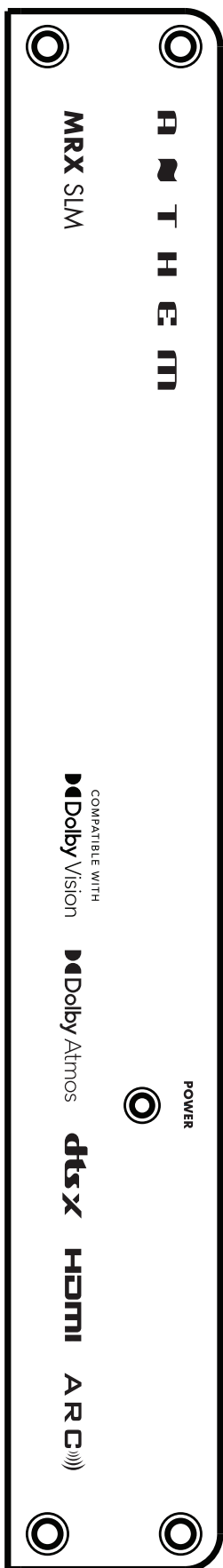

THE BIG PICTURE MRX SLM REAR PANEL

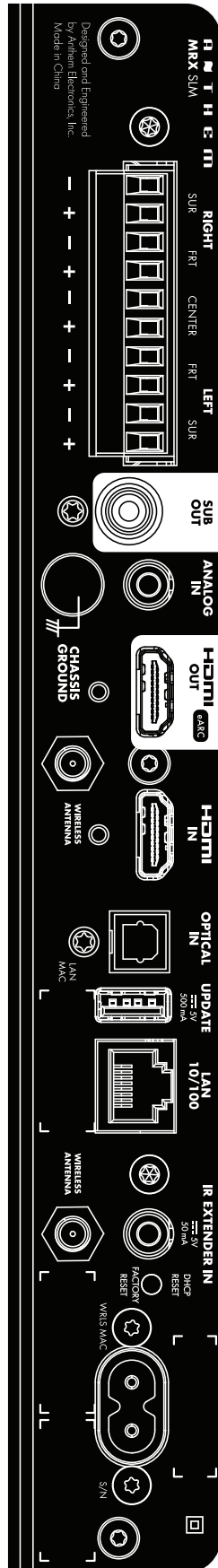



DESIGNED IN NORTH AMERICA

+1 905-564-1994
8:30 am - 5:00 pm M-F (ET)

www.anthemAV.com

2024-08-14